

Varenummer: 20167B452SW
 Beskrivelse: E+G
 Bred fod holder GN167-B45-2-SW

Mål

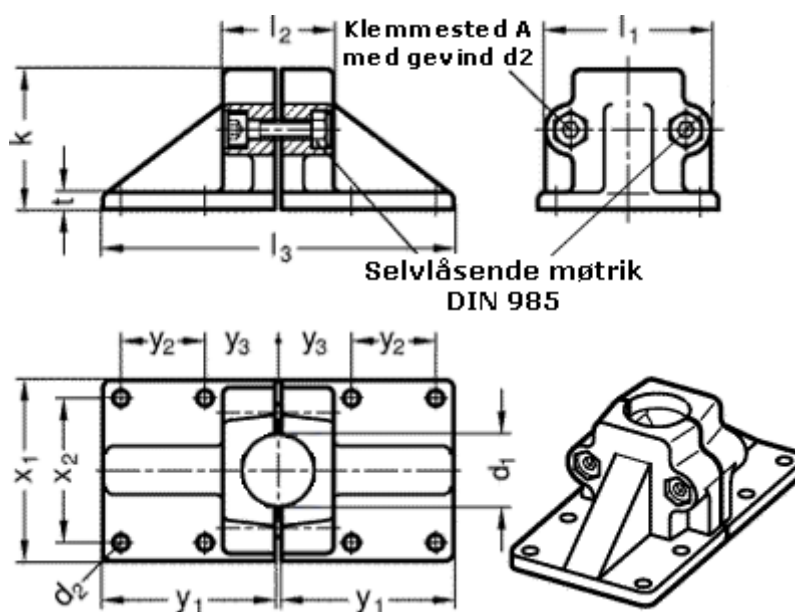

$d1 = B45$	$x1 = 115$
$d2 = 11$	$x2 = 90$
$d3 = M10$	$y1 = 108$
$k = 91$	$y2 = 50$
$l1 = 98$	$y3 = 45$
$l2 = 70$	
$l3 = 218$	
$t = 14$	